

CASELLA

HANDBOOK

Air Sampling Handbook

HB4071-03

April 2022

Casella
Regent House,
Wolseley Road,
Kempston,
Bedford.
MK42 7JY
T: +44(0) 1234 844 100
F: +44(0) 1234 841 490
E: info@casellasolutions.com

www.casellasolutions.com

Contents

Introduction	5
Introduction and Aims	5
Personal Air Sampling Dust and Fumes	6
Sampling Train for Dusts and Fumes	6
Apex2 Personal Air Sampling Pump	8
Types of Personal Sampling Heads	9
Total Inhalable Sampling Heads	9
IOM-type Head & Cassette (P109009A & P109010)	9
Conical Inhalable Sampler (P118200).....	10
Respirable Sampling Heads.....	11
Higgins-Dewell Cyclone Sampling Head (116000B).....	11
Dorr Oliver Sampling Head(P101010).....	12
Aluminium Cyclone for Respirable Dust	12
Other Sampling Heads(B8221/Z).....	13
Lead Sampling Head.....	13
Open Faced Filters (P109104 & B7632/Z)	13
Solder Fume Sampling Head (P109049).....	14
Asbestos Sampling Head	14
Care and Maintenance of Sampling Heads	15
Filters and Filter Media	16
Types of Cassettes	20
Blank Sampling Cassette Housings	21

Pre-Loaded Cassette Housings.....	22
Pre-Weighted Filter Cassettes	23
Match Weighed Cassettes	24
PUF Filters for Size Selection	25
Sampling for Gases and Vapours	27
VAPex Low Flow Pump	28
Low Flow Adaptors and Constant Pressure Mode	29
Low Flow Adaptors	31
Types of Sorbent Tube	31
Bubblers and Impingers.....	32
Grab Sampling.....	33
Calibration.....	35
Flow Detective Air Flow Calibrator.....	35
Field Calibration	36
Primary Calibration.....	37
Your Personal Sampling Pump.....	38
Batteries.....	38
Pulsation	39
Back Pressure Capability.....	39
Constant Pressure Control.....	40
Size, Weight, Wearability and Motion Sensing.....	41
Connectivity and Data Download.....	41

Intrinsic Safety.....	42
Area Sampling and Environmental Sampling ...	43
Area Sampling	43
Vortex3 High Flow Pump	43
Microdust Pro.....	44
Dust Detective.....	46
Guardian2	47
Glossary.....	48

Introduction

Introduction and Aims

Many industrial and construction sites have the potential to expose their employees to harmful dust, vapours and gases. Inhalation is usually the most significant route of entry into the body and so monitoring the air they inhale is vitally important. This handbook aims to give an introduction to air sampling applications and the equipment required.

The information contained in this handbook refers only to equipment that Casella supplies and it is not intended to advise, or influence adopted sampling strategy. Selection of the correct sampling head and flow rate should be dictated by local legislation and guidelines, typically issued by the relevant regional health and safety organisations.

As an additional resource to this handbook, Airsamplingsolutions.com is a dedicated website with a searchable database of hazardous materials. This has links to HSE and NIOSH methods, sampling kits, accessories and consumables, along with exposure limits and flow rate settings.

Personal Air Sampling Dust and Fumes

Sampling Train for Dusts and Fumes

In general terms a known volume of air is drawn using a sampling pump through a suitable sampling medium. For particulates and fumes this would be a filter paper. An appropriate sampling train for personal monitoring would look like this with the sampler mounted in the breathing zone.

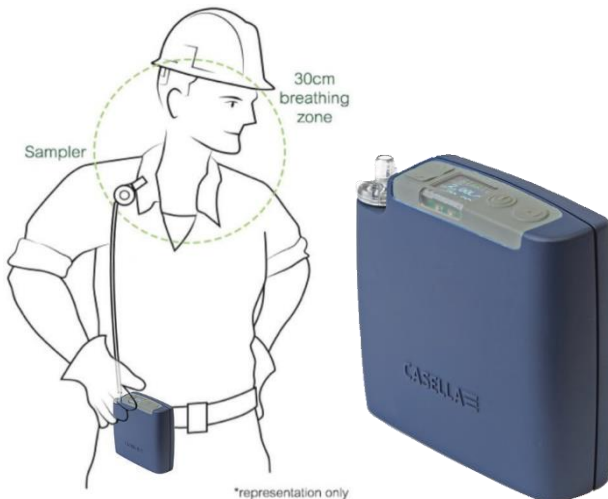

A personal sampling pump would be connected to a sampling head containing a suitable filter via a length of tubing. The pump is normally worn on the belt, but it can be mounted on the back or the chest in a suitable harness. The sampling head, however, must be in the breathing zone for a valid sample.

Dust is particles of solid material less than $1\mu\text{m}$ to $100\mu\text{m}$ diameter. Larger particles are too heavy to remain airborne. Fumes are solid

particles formed by condensation from a gas and the particle size is typically $<1\mu\text{m}$.

Dust can further be categorized into size fractions: Total Inhalable Dust, Respirable Dust and Thoracic dust. Below is a graph of the

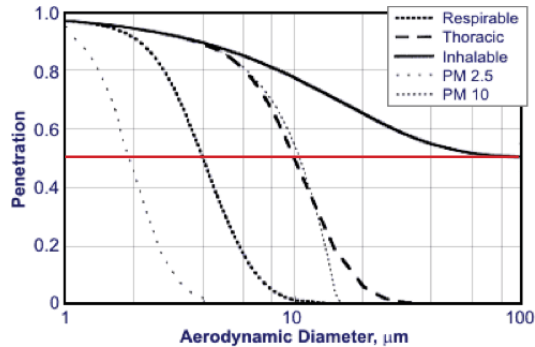

ACGIH / CEN / ISO sampling convention where the red line indicates a 50% (D50) cut point.

In real terms, Total Inhalable Dust is the fraction of particulates (up to $100\mu\text{m}$) that enters the nose and mouth during breathing and can be deposited anywhere in the respiratory tract. Respirable dust, however, is less than $4\mu\text{m}$ and can penetrate into the deep lung where gas exchange takes place. It is this fraction which is more harmful because these dust particles cannot be expelled by the body's own defences. It should be noted that if you sample for Total Inhalable Dust, it will also contain those smaller fractions.

Different sampling heads are needed to measure the different fractions, see Types of Personal Sampling Heads. A pre-weighed filter is used, and a volume of air is drawn through the filter using a personal sampling pump at a set flow rate over a known amount of time. It is important to calibrate the flow rate before and check again after sampling. The filter is re-weighed post sampling and the weight gain noted. The calculation of concentration is as follows and is expressed in mg/m^3 .

CALCULATION OF CONCENTRATION

$$\text{Concentration (mg/m}^3\text{)} = \frac{\text{Weight Gain (mg)} \times 1000}{\text{Flow rate (l/min)} \times \text{time (min)}}$$

Apex2 Personal Air Sampling Pump

The Apex2 is the latest generation of personal sampling pump, which can now be monitored from your mobile phone or tablet (Android and iOS) without disturbing the wearer using the Airwave App and Bluetooth® 4.0 connectivity (Plus and Pro models). On models without remote connectivity, all the running parameters are clearly displayed on the pump LED screen.



Motion sensing allows you to confirm that the pump is being worn, and the slim ergonomic design provides a high degree of wearer acceptance. To provide greater protection against dust and water ingress the pump is IP65 rated, and its smooth finish makes it easier to decontaminate.

The Apex2 has a maximum flow rate of 5 l/min and an impressive back pressure capability, which ensures it operates reliably with a wide range of filter media. Inlet pressure is continually sensed to establish filter loading and aid diagnostics. Gas and vapour collection is also possible using various accessories for the pump.

On a full battery charge the pump is designed to operate for up to three 8 hour shifts before it needs to be charged up. A gauge shows the battery charge level, and on Pro and Plus models, the remaining run time.

Types of Personal Sampling Heads

Total Inhalable Sampling Heads

Total inhalable sampling heads collect all fractions of particulates (up to $100\mu\text{m}$) which enter the nose and mouth during breathing, i.e. everything that is available in the air to be inhaled. It is possible to size select using some of the heads with the use of Poly Urethane Foam (PUF filters (see PUF Filters for Size Selection)) but if you are only interested in the Respirable Fraction, it would be preferable to use a cyclone head.

IOM-type Head & Cassette (P109009A & P109010)

The IOM-type inhalable dust sampler is the most commonly used head for Total Inhalable Dust sampling. Developed by the Institute of Occupational Medicine, this type of sampler is used with a cassette ensuring that no sample is lost on the walls of the sampler. The whole cassette including the filter paper is pre- and post-weighed ensuring that the entire sample is accounted for. The diagram below shows the component parts.

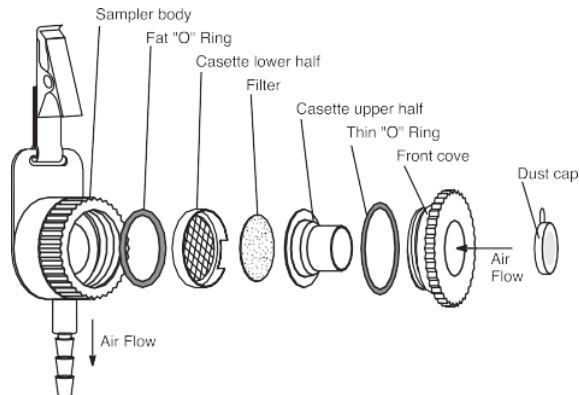

The IOM-type head uses a 25mm filter housed in a cassette which is pre-weighed as a single unit. It is operated at a 2.0l/min flow rate.

It has the advantage of being able to sample different size fractions simultaneously through the use of PUF filters. See PUF Filters for Size Selection for description of its use with PUF filters.

Conical Inhalable Sampler (P118200)

The Conical Inhalable Sampler (CIS.) is primarily used when there is a need to sample a high concentration of particulate. A larger size of filter is therefore used (37mm). The cone is designed to spread the sampled dust evenly over the filter which is housed in a cassette. The cassette, complete with 37mm filter is pre-weighed as a single unit. The CIS head is operated at a flow rate of 3.5l/min.

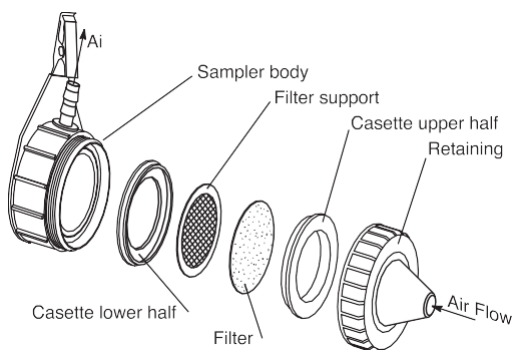

Like the IOM-type head, the CIS head has the advantage of being able to sample different size fractions simultaneously through the use of PUF filters. See PUF Filters for Size Selection for description of its use with PUF filters.

Respirable Sampling Heads

Respirable dust is usually collected using a cyclone head. The shape of the head rapidly circulates the air drawn through and the larger particles are forced to the outside of the air stream where they drop into a grit pot. These are discarded. The smaller particles are deposited onto the filter for analysis. Size selectivity of the head is dependent on the shape of the cyclone and also the flow rate, so it is vital that the flow rate set remains steady throughout the sampling so as not to introduce errors. They are designed to meet the ACGIH / CEN / ISO size-selection curve with a 50% cut point at 4.0µm.

Higgins-Dewell Cyclone Sampling Head (116000B)

The Higgins-Dewell (HD) cyclone sampling head is most commonly used in Europe and is usually made from conductive plastic, although metal versions are available.

The diagram below shows the component parts.

The cyclone head uses a 25mm filter cassette which can be weighed complete. 37mm heads are also available. The cyclone operates at 2.2l/min.

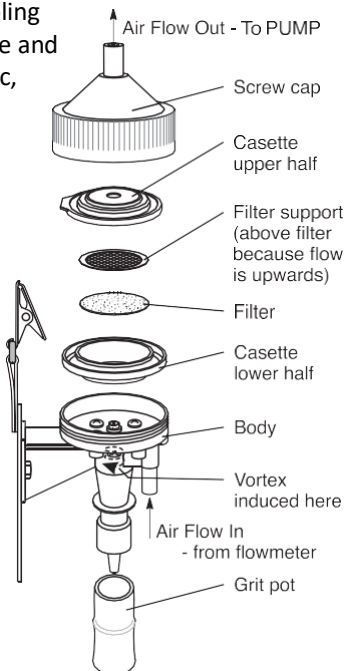

Dorr Oliver Sampling Head (P101010)

The Dorr Oliver Sampling Head is used in conjunction with a 37mm 3 piece open face filter cassette. This is more commonly used in the USA.

The cyclone operates at 1.7l/min.



Aluminium Cyclone for Respirable Dust

The aluminium cyclone removes electrostatic effects and is small and lightweight. It is available in both 25mm and 37mm versions. It is used in conjunction with an open faced, 3-piece cassette with filter. It is designed to provide a sharp size selection at flow rates of 2.5L/min (50% cut 4µm) and 3.8l/min (50% cut 3.5µm).



Other Sampling Heads(B8221/Z)

Lead Sampling Head

This design was developed to sample for radioactive particles (UKAEA) and lead. This head uses a 25mm filter at 2l/min.

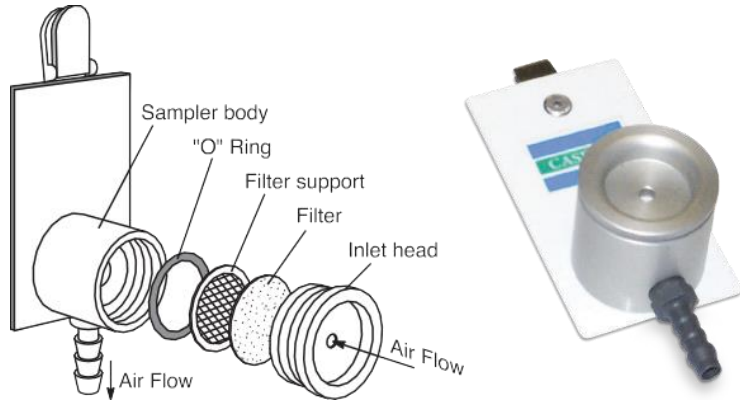

Open Faced Filters (P109104 & B7632/Z)

The open faced filter holder is available in 25mm or 37mm versions.

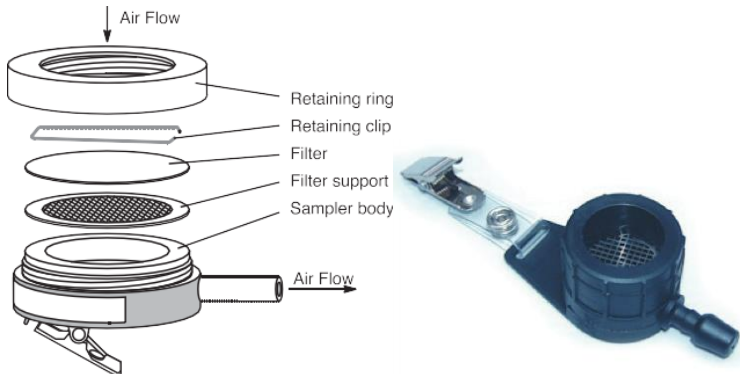

Solder Fume Sampling Head (P109049)

This head is designed for sampling the fumes generated by the rosin-cored solder used in the electrical and electronic industries.

Use 13mm filters at a flow rate of 1l/min for long term sampling or 2l/min for short term sampling.

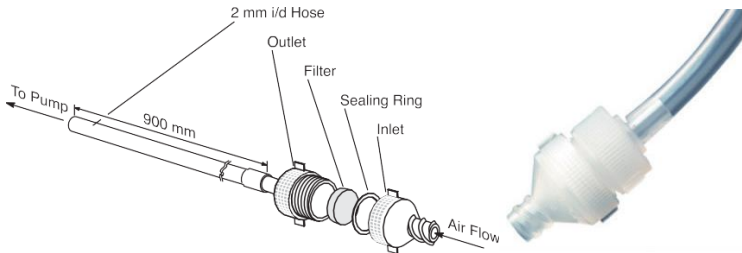

Asbestos Sampling Head

Airborne asbestos fibres are sampled, like general dust sampling, by drawing a measured volume of air through a membrane filter. However, rather than gravimetric analysis, the fibres are counted. This is done by mounting the filter onto a microscope slide then dissolving the membrane with solvents. Fibres on a measured area of filter are counted using phase contrast microscopy (PCM) and the number concentration of fibres in the air is calculated.

Casella offers specific sampling accessories for the analysis of asbestos fibres: An open faced filter holder fitted with an electrically conducting cylindrical cowl is required along with MCE filters with a printed grid. MCE filters (a mixture of cellulose acetate

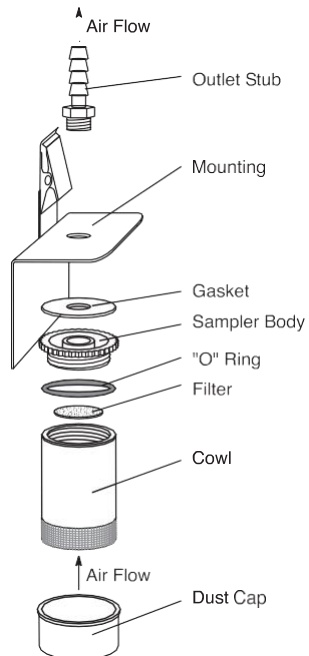

and cellulose nitrate) are recommended for asbestos sampling as they are readily rendered transparent. Pre-loaded asbestos cassettes are also available in pore sizes of 0.8 μ m and 0.45 μ m for ease of use.



These can also be purchased as pre-assembled plastic sampling heads complete with 0.8micron filters. (Part Number P101022)



Care and Maintenance of Sampling Heads

Air sampling heads should be cleaned after use, this should be done with warm soapy water unless otherwise instructed to do so. Grid pots on cyclones should be emptied and cleaned in the same manner.



Filters and Filter Media

Filters are available in a number of different materials; the most common type is glass fibre, where gravimetric weighing is the only analysis. If further analysis is required, the hazard being sampled is corrosive or if there is interference with glass fibre then other types are recommended. Please check your standardised method for the correct filter to use. Filters are also available pre-weighed or pre-loaded into cassettes.

Filter Type	Description	Main Properties	Air Sampling Applications
Glass Fibre 	These low cost filters are commonly referred to as depth filters. They are ideal for general gravimetric air sampling and analysis. Suitable when no other analysis than weighing is required. Binder and additive free. Available unweighed and pre-weighed.	<ul style="list-style-type: none"> • Fastest flow rate • High capacity load • No electrostatic problems • Low pressure drop • Up to 500°C range 	<ul style="list-style-type: none"> • General gravimetric • Isocyanates • Ethylene Glycol • Air Quality Fractions
MCE 	Developed from a mixture of cellulose acetate and cellulose nitrate, MCE	<ul style="list-style-type: none"> • Dissolves completely • Readily rendered 	<ul style="list-style-type: none"> • Metal Dust Analysis • Asbestos and Man-

	<p>filters are suitable for air monitoring where further analysis other than gravimetric is required. They are available in a range of pore sizes. They are also available in gridded versions for fibre counting.</p>	<p>transparent for fibre counting</p> <ul style="list-style-type: none"> No moisture issues 	<p>Made Fibres</p> <ul style="list-style-type: none"> Air Quality
<p>PVC</p> 	<p>High quality filters for measuring dust, silica and chromium. They have a low tare weight so suitable for lower sample levels and have gravimetric stability. Low ash levels means interference free silica determinations</p>	<ul style="list-style-type: none"> Low tare weight Silica free and low ash Non-oxidizing surface Low moisture pick-up 	<ul style="list-style-type: none"> Gravimetric Analysis Hexavalent Chromium Silica
<p>PTFE</p> 	<p>High quality, chemically resistant filters suitable for aggressive environments.</p>	<ul style="list-style-type: none"> Hydrophobic Chemically inert Suitable for aggressive 	<ul style="list-style-type: none"> Alkaline Dusts PAH's Pesticides

	<p>Suitable for highly sensitive, interference free determinations. Low tare weight means gravimetric stability and suitable for use with lower sample levels.</p>	<p>environments</p>	<ul style="list-style-type: none"> • Isocyanates • Ambient Air Quality
<p>Polycarbonate</p> 	<p>These filters have a smooth glass-like surface with precise pore size and distribution for specific filtration and separation. Available in a range of pore sizes. They are optically transparent and non-staining which means they are ideal for sample observations</p>	<ul style="list-style-type: none"> • Smooth surface for microscopy • Precise pore size and distribution • Chemically and biologically inert • Strong • Optically transparent & non-staining 	<ul style="list-style-type: none"> • Asbestos Fibres • Scanning Electron Microscopy Applications
<p>Quartz</p>	<p>Quartz filters are heat treated for improved purity allowing trace level</p>	<ul style="list-style-type: none"> • High purity for trace level analysis 	<ul style="list-style-type: none"> • High Temperature Applications

	<p>analysis. They are heat resistant and suitable for use in stacks or for diesel emissions and are acid resistant. They have a high flow rate. Binder and additive free.</p>	<ul style="list-style-type: none"> • Temperature resistant to 300°C • Autoclavable • High filtration rate 	<ul style="list-style-type: none"> • Stack Sampling • Diesel Particulates • Acidic Gases
<p>Silver</p> 	<p>Made from high purity silver, these filters can be cleaned and re-used. They have a smooth surface for particle capture and easy observation. They are available in different pore sizes</p>	<ul style="list-style-type: none"> • 99.97% pure silver • High temperature resistance • High chemical resistance • Uniform porosity and thickness 	<ul style="list-style-type: none"> • Bromine • Asbestos by TEM • Silica by X-Ray Diffraction

Types of Cassettes

Heads like the I.O.M. type head and the Higgins Dewell cyclone have a cassette included in their design. For other heads like the Dorr Oliver Cyclone, the hygienist would opt for a separate cassette to fit into the sampler.

Sampling cassettes are convenient as they, not only protect the filter during sampling but are good for transportation. Generally there are two different types: A 2-piece and a 3-piece design.

A 2-piece design would be used for closed face sampling.

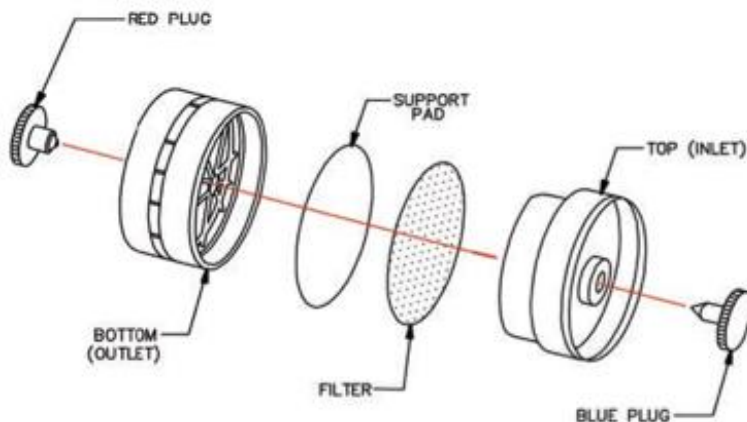

Closed face sampling refers to sampling where only the plugs are removed, and air is drawn through the filter. A 2-piece cassette is better for this because the cassette itself exerts electrostatic forces which attract the contaminants to the walls of the cassette and a 2-piece cassette has less surface area for contaminants to cling to instead of being caught on the filter.

The 3-piece cassette offers more protection to the filter by having an extra ring which offers protection for open faced sampling where the inlet piece as well as the plug are removed for sampling. The 3-piece cassette is also used in conjunction with cyclones.

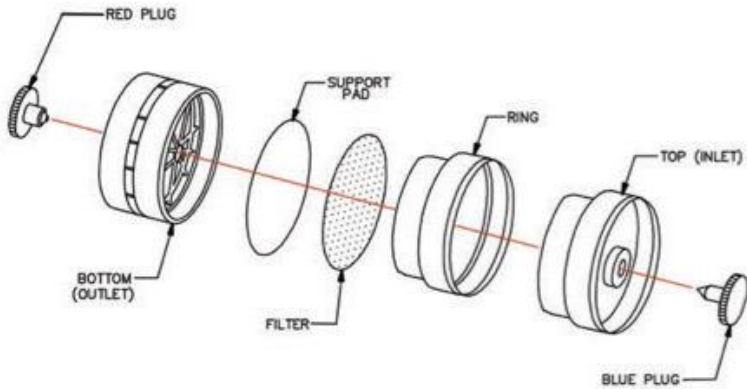

Please take care to attach your cassette the correct way. The wagon wheel design at the base is the outlet face, otherwise your sample will be deposited on the support pad.

Casella offers a range of different cassette options. Here are the different types and when you might use them:

Blank Sampling Cassette Housings

These are available in either a 2-piece or 3-piece cassette in 25mm or 37mm. Blank cassettes enable you to load your own pre-weighed filter, either a standard GFA filter for gravimetric data or a more specialist filter medium for further analysis.



The most common material for these cassettes is styrene which is clear and provides excellent visibility. We also offer an opaque version if your sample is likely to be light sensitive. Choose a polypropylene version if you need protection against solvents or

choose a carbon loaded polycarbonate cassette to minimise electrostatic interference.

Filter supports can be used behind filter membranes to support them from collapsing while still allowing free air flow through them.

Available in 3 different styles:

- Cellulose pads are made up of 100% pure cellulose and the most common support used in filter cassettes.
- Porous plastic supports work well when sampling chemicals that are not compatible with cellulose.
- Stainless steel grids can be used in a wide range of filter holders and can easily be cleaned and re-used.

Pre-Loaded Cassette Housings

These are preloaded with a choice of filter media e.g. PVC, MCE or PTFE and you would use them when there is chemical analysis or extraction to be done on the filter post sampling. That means you can just remove the plugs and start sampling. If it is just a gravimetric result that you need, choose pre-weighed or match-weighed cassettes. They are available as 25mm or 37mm cassettes with your choice of filter media. Please consult your standard method for the media you need.



Pre-Weighted Filter Cassettes

Pre-weighted filter cassettes are pre-loaded with a PVC membrane at a testing laboratory and then, after sampling, returned to the same laboratory for re-weighing. The process of weighing is included in the price of these cassettes. To comply with directives it is vital that you return the cassettes to the SAME laboratory as the tare and the secondary weight must be performed on the same microbalance under the same environmental conditions. Environmental conditions have a significant effect on weight and because the filter is weighed to 0.01mg, the variation and calibration between microbalances also becomes a significant factor. Each cassette is labelled with a weight and serial number for identification purposes.

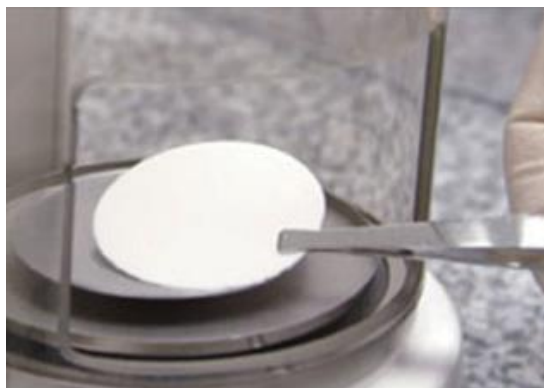

Match Weighed Cassettes

These offer the convenience of the pre-weighed filters in that the filter is pre-loaded, and you can just begin sampling. You do not need to return them to the same laboratory to comply.



Each cassette contains two filters which are matched in weight within a tolerance (50 μ g for the MCE filters and 20 μ g for the PVC filters). From the below diagram you can see that air is drawn in through the inlet and deposited on the test filter. There is a second filter underneath which acts as a blank. After sampling, both filters are equilibrated and re-weighed and the difference in weight is the amount of contaminant.

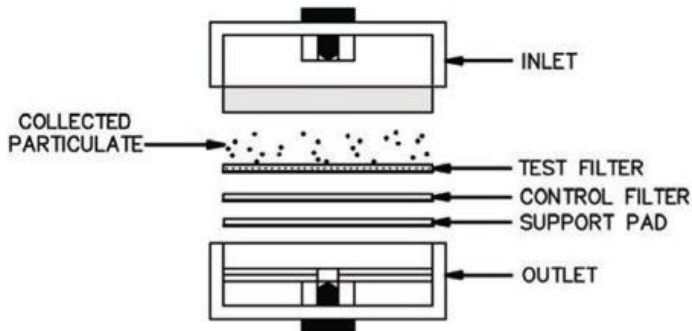

In re-weighing, it is quite possible that the bottom control filter may weigh more than the test filter but within the tolerance stated. If this is the case, it may be that no sample has been taken or that the inlet/outlet of the cassette has been switched.

PUF Filters for Size Selection

It should be noted that there are different conventions for size selection for Occupational Hygiene and for the Environment.

While Occupational and Environmental agencies both measure particulates in air, they have different definitions and methodologies for assessing the particulates.

Occupational Hygienists sample for Total Inhalable, Thoracic and Respirable fractions whereas for Environmental sampling, we would refer to PM10 and PM2.5 fractions. In general terms PM10 compares closely with the Thoracic Fraction and PM2.5 equates with the High Risk Respirable fraction. However, the sampling conventions, whilst similar, are not identical.

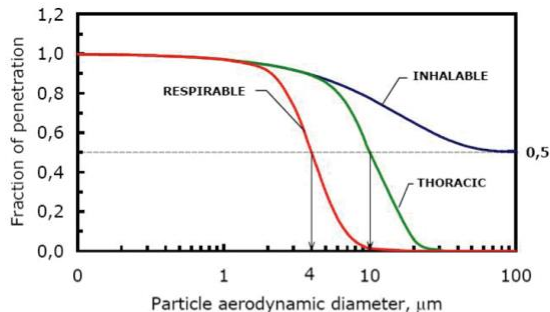

Probability or aerosol penetration as a function of aerodynamic diameter, internationally agreed by CEN/ISO/ACGHI

It is possible to insert PUF discs into either a standard I.O.M. type head or a Conical Inhalable Sampler (CIS) to transform them into a more versatile sampler and it is possible to sample for inhalable and respirable fractions either individually or simultaneously.



These PUF (polyurethane foam) filters are available with a pore size which corresponds to the respirable and the thoracic fraction.

Respirable particles deposit on the filter at the back of the cassette and can be analysed separately. The larger particles are collected in the PUF. For the total inhalable dust result would be the gravimetric analysis of the PUF and the filter together. You would operate the IOM type head at 2l/min and the CIS at 3.5l/min.

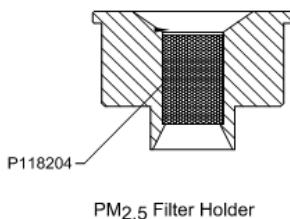
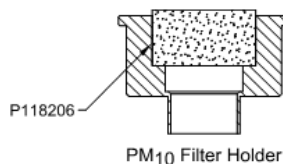
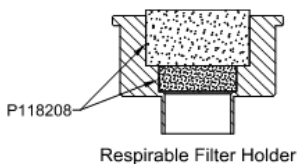

In environmental sampling PUF filters are available in PM10 or PM2.5 sizes, see Are sampling and environmental sampling.

Sampling for Gases and Vapours

We have looked at the sampling train for the sampling of particulates in Personal Air Sampling Dust and Fumes. For the sampling of solvents, gases and vapours a different sampling strategy is required.

A gas is a substance that is not a liquid or a solid at room temperature and pressure, in contrast to a vapour which is described as the gaseous state of a substance that is solid or liquid at normal room temperature and pressure. Taking the example of a solvent, this might be a liquid at room temperature, but a proportion of that solvent will have evaporated and be in the gaseous phase.

The most common method for collection of gases and vapours is by sorbent tube but the use of a bubbler/impinger may also be used, see Bubblers and impingers.

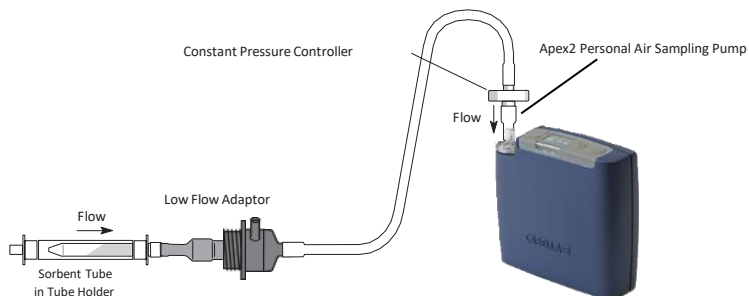

Above is a typical sample train using a sorbent tube. The ends of the sorbent tube are broken off and inserted into a tube holder which is then connected to a personal sampling pump. Generally the flow is lower (typically 20-200ml/min) and so either a dedicated low flow pump may be used or a medium flow pump, e.g. a Casella Apex2 with a Low Flow Adaptor. The flow rate needs to be set and checked pre and post sampling.

VAPex Low Flow Pump

The VAPex is the latest generation of personal sampling pump for gases and vapours, which can now be monitored from your mobile phone or tablet (Android or iOS) without disturbing the wearer using the Airwave App and Bluetooth® 4.0 connectivity (Pro model). On models without remote connectivity, all the running parameters are clearly displayed on the pump LED screen.



Motion sensing allows you to confirm that the pump is being worn, and the slim ergonomic design provides a high degree of wearer acceptance. To provide greater protection against dust and water ingress the pump is IP65 rated, and its smooth finish makes it easier to decontaminate.

The VAPex is designed for particularly low flow sampling applications with a range of 20 to 500 ml/min and an impressive back pressure capability, which ensures it operates reliably with a wide range of sorbent tube media. Inlet pressure is continually sensed to establish sorbent tube loading and aid diagnostics. It is also possible to fill a bag of gas using the gas bag outlet and associated bag fill mode on the pump.

On a full battery charge the pump is designed to operate for up to four 8 hour shifts before it needs to be charged up. A gauge shows the battery charge level, and on the Pro model, the remaining run time.

Low Flow Adaptors and Constant Pressure Mode

For the sampling of gases and vapours a lower flow rate is generally set (20-200ml/min). You may either use a dedicated low flow pump or a standard medium flow rate personal sampling pump (1-5l/min) using a low flow adaptor and a constant pressure controller. Using a standard personal sampling pump it is possible to sample, not only with one tube, but actually with two or even 4 simultaneously.

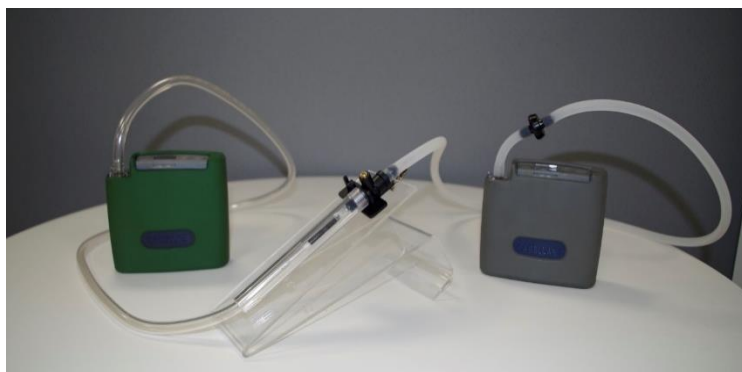

You would use a set-up like the one illustrated in the diagram above to set the flow. Set the flow on the personal sampling pump to around 1.5l/min. Attach the constant pressure regulator, low flow adaptor and sorbent tube (in holder) with both ends snipped off into the flowmeter. Using the screw on the side of the low flow adaptor, adjust the flow to the desired rate (20-200ml/min). The low flow adaptor basically restricts the flow drawn through the tube. Once the flow is set, remove the sorbent tube and continue the sampling with a fresh one.

The constant pressure controller is there to maintain the flow. It maintains a constant low pressure level inside the tubing between the pump and the sample holder. (Some pumps have this feature incorporated into the pump itself, like the Casella Apex2, but

you would need to consult your manufacturer's handbook) If the regulator detects a change in pressure, due to loading of sample for example, the speed of the motor of the pump will adjust to maintain the correct level of pressure.

This method of maintaining constant pressure means that more than one tube can be sampled simultaneously via the use of a manifold or by using a twin sampler (see types of low flow adaptors below). With the constant flow method of control, the pump will draw directly at a steady flow rate which means that should you have more than one sample attached and one side gets blocked, you have no idea which proportion of air is being drawn through which side and therefore are not able to make accurate exposure calculations.

With the constant pressure method of control, it is the level of pressure in the tube that is maintained. The force driving the flow rate for each side of the split remains independent so even if one side of the split is shut off completely, the other side would still maintain its set flow rate.

Low Flow Adaptors



P109032, shown above, shows the single low flow adaptor with the protective tube holder, the screw flow adjuster and the constant pressure controller.

P109074 shows a twin port sampler which allows two sorbent tubes to be sampled simultaneously. The flow rate in each port can be set independently meaning that either two separate compounds can be sampled for or the same compound but at different flow rates, if there is concern about breakthrough (see below). Duplicate sampling at the same flow rate can also be done to ensure consistency of results.



Types of Sorbent Tube

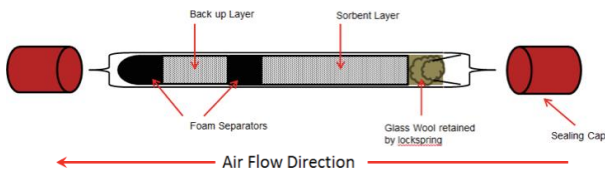

A sorbent tube contains a material which adsorbs the vapour or gas onto its surface during sampling. This is then extracted and analysed in a laboratory to give you a result for your exposure calculations.

A typical sorbent tube would look like the diagram above with sorbent layers separated by either foam or glass wool. The second, smaller layer of sorbent is a back-up layer and is also analysed by the laboratory. If there is breakthrough from the first layer, i.e. it

becomes so saturated with sample that some of it leaks through into the second, back up layer, the sampling needs to be repeated.

Charcoal and silica gel are the most common sorbent materials. Please check your standardized method to find out which sorbent tube you require.

Charcoal is the standard sorbent tube generally used for organic vapours. They are suitable for most aromatic hydrocarbons and alcohols.

Silica is suitable for polar hydrocarbons, methanol, amines, inorganic acids and low molecular weight mercaptans (thiols). Some of the tubes in the range are pre-treated (e.g. with 2,4-dinitrophenylhydrazine) for sampling of specific chemical hazards.



It is important to mount the tube so that the air flow through the tube is correct. Generally the smaller sorbent layer should be nearest the pump. Always ensure that the tube is near vertical during sampling and that there is a clear break at the end of the tube of at least 2mm in diameter to allow the drawing through of air.

Bubblers and Impingers

For some applications, using an impinger is required e.g. chlorine gas. Impingers are glass tubes, containing a liquid. Air is drawn through the liquid, as with the other sampling methods, and the sample is captured by the solution. This solution is then analysed by the laboratory for the contaminant. Like sorbent tubes, this is usually done at low flow rates and so a low flow adaptor and constant pressure controller are also required or a specific low flow pump.

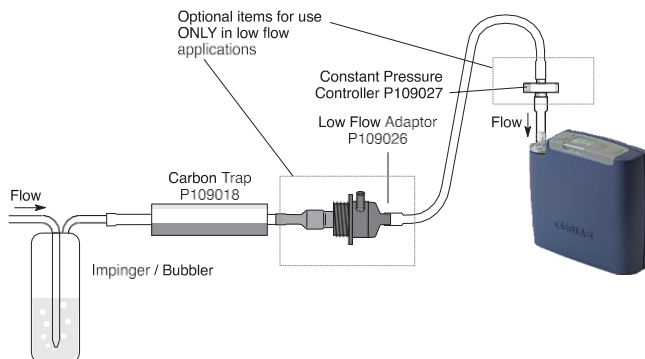

Above is a typical sampling train for an impinger. An impinger may be mounted on the side of an air sampling pump or put into a special holster and placed near the worker's breathing zone.

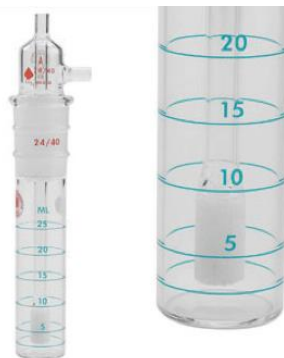

Grab Sampling

Grab sampling is a screening technique. It is used to give the concentration of a contaminant at a specific time and location and either confirms the presence of or identify a suspected contaminant.

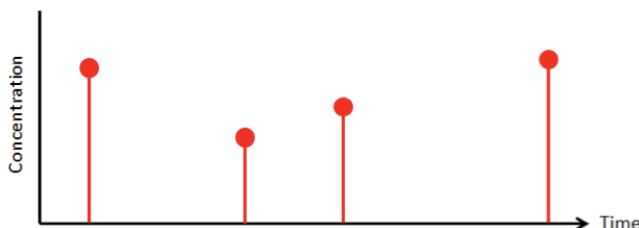

A gas sampling bag would be used made from a material such as Tedlar® which is a chemically inert film.



Attach the Tedlar bag to the outlet of the pump using a suitable length of tubing and a luer fitting e.g. Casella TUC12. In some pumps, the bag fill mode is automatic. Once the pump is set running, the pump will stop automatically when it senses the bag is full. If your pump does not have this feature, work out the time you need to fill the bag. Take care not to overfill the bag.

Calibration

A standard method (e.g. NIOSH, OSHA, MDHS method) will recommend a particular flow rate for sampling. This needs to be set using a calibrator pre-sampling and post sampling. A simple rotameter may be used in the field or a digital flowmeter.

Flow Detective Air Flow Calibrator

The Flow Detective is the latest generation of digital flow meter for the accurate calibration of personal sampling pumps and other equivalent devices.

The Flow Detective is small and robust with no moving parts and with the inbuilt Li ion battery the unit will run for 70 hours between charges.



The Flow Detective has two separate models, the Standard model is a flow meter for medium flow air sampling pumps (0.5 – 5L/min). This can be used to calibrate pumps by noting the values from the display accordingly. The Plus model has Bluetooth connectivity to the Airwave App. After calibration, the App will allow calibration data to be sent via email for easy record keeping. When used to calibrate the Apex2 pump, this has the further benefit that Airwave will control both the Apex2 and Flow Detective and automatically calibrate to selected flow rates, making calibration very quick.

Flow Detective Plus models will also allow calibration at lower flows (20mL – 0.5L/min) used for gas and vapour sampling for sorbent tubes.

A unique feature of the Flow Detective is pulsation detection. This is important because in ISO13137, the international standard for air sampling pumps, it stipulates that pulsation must be below 10%. Pulsation is important for stable flow, especially when using cyclone sampling heads to ensure an accurate size cut. The Flow Detective is the only flow meter on the market to detect pulsation and display if levels are over 10%.

Field Calibration

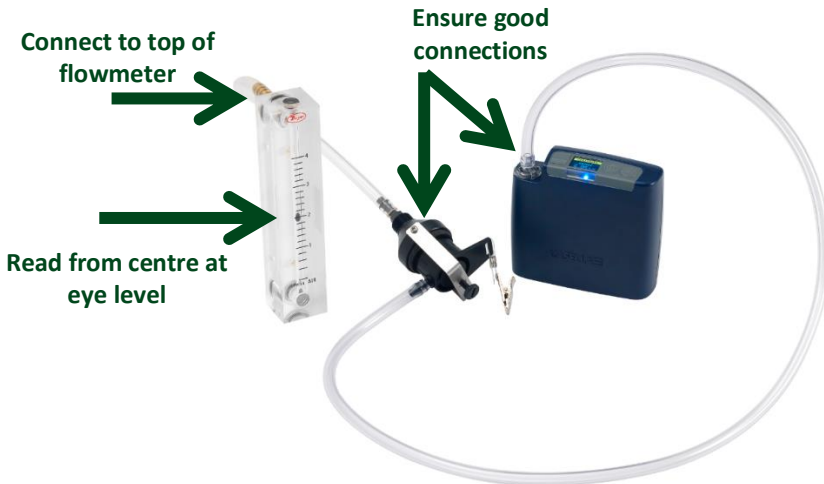

Above is a diagram of the set up for the field calibration using a flow-meter. This is a simple method for applications of dust sampling where the flow rate is generally set between 2 and 2.2l/min. The flowmeter is a graduated tube. The flow is read from a float which is inside the graduated tube. Make sure you are at eye level with the tube and that you read the level from the correct part of the float. For the best levels of accuracy, choose a flow meter with a range that is tailored to the flow rate you're looking at and where there are clearly spaced graduations around your flow rate of interest.



For low flow applications (0-200ml) it is possible to use a flowmeter, again, centered around the flow rate of interest. The Dry-Flo meter pictured above is most suitable for this type of measurement.

For another alternative an electronic calibrator can be used (see Primary Calibration).

Primary Calibration

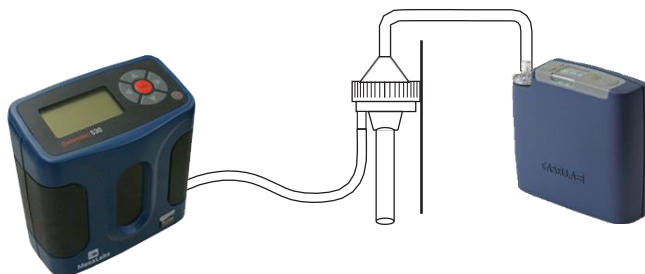

The MESA Defender is an example of a Primary Calibrator and works by detecting and timing a passing piston electronically. The flow rate is displayed on the LCD screen. Mass flow type primary calibrators are also available in the market and are equally as simple to use.

Primary calibrators are often used to check the calibration of secondary calibrators such as the Flow Detective or Rotameter.

Your Personal Sampling Pump

Carrying out personal exposure air sampling requires the user to choose the correct air sampling head and media, but the most important part of the sampling train is the sampling pump itself. It is vital that your choice of pump enables you to carry out effective sampling.

ISO13137 is the recognised performance standard for personal sampling pumps. Primarily, ensure that your pump fully meets this standard. But the conditions under which the personal sampling pump needs to operate vary differing media and environmental factors may affect the quality of the final result. Understanding the design specifications of a sampling pump enables the Occupational Hygienist to make an informed choice of device to meet their particular sampling requirements.

But what are the features that you would need and what do the specifications actually mean?

Batteries

The choice of batteries in a sampling pump is a major consideration. The primary function of the battery is to drive the motor for the entire monitoring period. It has to be powerful enough to cope with increasing back pressure (as the media becomes loaded and the pump has to draw harder). The



most recent designs of pumps use Li-Ion batteries in place of NiMH batteries, with the advantage of longer run times, no memory effect (where the battery will only discharge part of its capacity) and a smaller overall size meaning a smaller sampling pump.

Pulsation

ISO13137:2013, the standard for personal sampling pump manufacture states that “the pulsation shall not exceed 10% of the flow rate” but what is pulsation and why is it so important?

With every cycle of the pump, air is drawn in and expelled simultaneously and this process of reciprocation causes an uneven flow through the sampling train. Pulsation is the measure of the difference in air flow between cycles. A large pulsation value means that the size cut performance of the cyclones used can be affected because their performance is flow rate dependent. In addition, less sample is collected using pumps that generate significant pulsation.

Back Pressure Capability

It is the filter media used in the sample train is by far the biggest factor, however. The motor of the pump needs to work harder to pull air through the media than it would do free air. The smaller the diameter and the pore size of your filter and the greater the flow rate, the greater the back pressure and the harder the motor needs to work. In addition, as the media becomes loaded during the course of the sampling, a greater back pressure is exerted. As well as being a drain on the battery, the pump needs to be powerful enough to overcome the resistance.

Back pressure in air sampling is generally measured in inches or centimetres (cm) of water. Below is a table (Figure 8) of approximate back pressures exerted by different unloaded MCE filters at different flow rates. Throughout the course of the sampling, back pressure will increase from these levels as the filter becomes loaded.

Flow Rate ml/min	37mm MCE/0.8µm	25mm MCE/0.8µm	25mm MCE/0.45µm
1000	5cm	15cm	36cm
2000	10cm	31cm	71cm

2500	13cm	38cm	89cm
3000	15cm	46cm	102cm
4000	23cm	64cm	127cm
5000	28cm	79cm	160cm

In choosing a pump, if the majority of the testing generates a high amount of particulate (like sandblasting) or if the requirement is for media with a small pore filter (e.g. 25mm 0.45µm MCE) then the choice of pump should be one that is able to overcome a large amount of back pressure.

Constant Pressure Control

Constant Pressure Control is another method of flow control, primarily used for low flow applications where multiple sampling is taking place. Up to 4 separate samplers (usually sorbent tubes) can be attached via a manifold. This method controls the flow rate by holding a constant pressure level in the tubing between the samplers and the pump.

This means that if one of the samplers became blocked or shut off completely, the pressure within the tubing is maintained and the flow rate in the other samplers remains constant. If this were a constant flow control system, the pump would sense the drop in total flow from one of the samplers and the motor would speed up to compensate.

For many pumps, this constant pressure controller is a separate piece of equipment which you would purchase as part of a low flow adaptor kit. If you are doing lots of low flow measurements, it is worth investing in a pump which has a Constant Pressure Mode built in, such as the Casella Apex2.

Size, Weight, Wearability and Motion Sensing

For the worker, having to wear a personal sampling pump is something they may not wish to do; in fact there have been instances where workers have removed the pump returning it at the end of the shift meaning no viable sample. The latest generation of Casella pumps include a motion sensor to ensure that the pump has been worn and that the sample is a valid one.

Taking into account the wearer, is it going to be worn on the belt or the chest? Will it be a large man or a small woman, for instance? What design of pump would achieve the most wearer compliance? Does the pump need to be decontaminated? If so, the case needs to be smooth. How waterproof does it need to be? Is it a harsh environment where additional protection is needed, e.g. a rubber boot?

Connectivity and Data Download

The whole reasoning around a monitoring programme is to gather data on your subjects' exposure so, of equal importance, is the reporting of that data. Would you prefer a bespoke manufacturer's software programme, or would you prefer to put the results into excel? What's your reporting process?

In the wider world, the use of smartphones and mobile devices are commonplace, and it is unsurprising that this trend filters down into monitoring equipment. The use of Bluetooth® low energy technology

means that it can be included in pump designs without draining the battery as Bluetooth®BR/EDR (classic Bluetooth®) was prone to do.



This means that the Occupational Hygienist can monitor and control the pump from their mobile phone or tablet (Android or iOS) without having to disturb the worker and additionally email the data alongside photos and notes direct from site.

Intrinsic Safety

If your working environment is a potentially explosive one, e.g., within oil and gas or chemical industries, then the pump must be certified intrinsically safe. This means that it must not be a source of ignition in a potentially explosive atmosphere. Ensure that the pump is compliant with International Standards.

Area Sampling and Environmental Sampling

Area Sampling

We have concentrated on methods for personal exposure monitoring. However, you may wish to look at background levels or static sampling to get an idea of the overall level of contamination within an area. Certainly, if there are high background levels of a particular substance it would indicate that you would need to do personal exposure measurements to ensure that the worker is not at risk. The reasons you may do area sampling include:

- To demonstrate the spread of contamination from a source
- To measure the likely exposure of workers in nearby areas or those not directly involved in the process
- To demonstrate the effectiveness of control measures
- To investigate the source(s) of contamination
- As a survey tool
- To check air quality within a confined space before entry

It should be remembered that fixed placed monitoring does not give a reflection of the amount of substance inhaled by an operator, only an indication of risk.

Vortex3 High Flow Pump

The Vortex3 is the latest generation of static, high flow rate sampling pumps, which can now be controlled and monitored from your mobile phone or tablet (Android or iOS) using the Airwave App and Bluetooth® 4.0 connectivity (Pro model only). On models without remote connectivity, all the running parameters are clearly displayed on the pump's full colour OLED screen.

To provide protection against dust/fibre and water ingress, the pump is IP65 rated, and its smooth finish makes it easier to decontaminate.

The Vortex3 has a maximum flow rate of 12 L/min and an impressive back pressure capability, which ensures it operates reliably with a wide range of filter media. Inlet pressure is continually sensed to establish filter loading and aid diagnostics.



On a full battery charge the pump is designed to operate for up to 2.5 hours before it needs to be re-charged but may also be run from a mains supply.

Microdust Pro

The CEL-712 Microdust Pro is a hand-held real-time dust monitoring instrument ideally suited for the measurement of particulate concentration such as from dust, smoke, fumes, pollen and other aerosols from combustion, materials processing, manufacturing, energy generation, vehicle engine emissions, and construction. Pollutants of this type reduce visibility, spread contamination and can cause illness and low worker productivity from the inhalation of toxic substances. Many of them are also recognised as contributory factors to many chronic and acute medical conditions, including asthma, bronchitis, and lung cancer.



The Microdust Pro instrument is not like traditional gravimetric methods of dust measurement, which require a significant sampling

period and are not suited to the real-time evaluation of trends in concentration levels. The Microdust Pro is an ideal survey instrument for the assessment of real-time particulate concentration in mg/m^3 . It is totally portable and has a detachable probe that allows operation in relatively inaccessible areas, making it suitable both for fixed site and for general survey applications. Data can also be downloaded for full analysis.

The Microdust Pro instrument uses a proven forward light scattering principle to make accurate and repeatable measurements of dust concentration. It provides the following features as standard:

- Graphical representation of concentration trends
- Internal data logging
- A simple and clear colour user interface
- Wide measurement concentration capability to suit a vast range of dust monitoring applications.

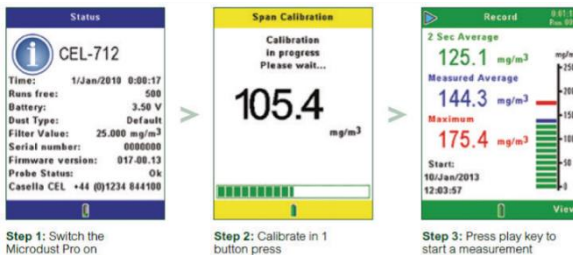

The best use of a real-time dust meter is to conduct dust measurements on walk-through surveys to identify problem areas that require more in depth sampling. They can be used to see how the exposure varies throughout the day or compare day to day measurements and to check on the effectiveness of control measures. They can also be calibrated to specific dust types to improve accuracy with optional accessories.

Caution should be used when using real-time dust meters to ensure the measurements are not relied on for personal exposure

assessments or assumptions are made about size fractions. Routine maintenance and calibration must not be ignored to avoid measurement drift or loss of sensitivity. Toxic dust components must not be measured as a real-time instrument cannot give accurate measurements of any subcomponents of dust.

Dust Detective

With greater awareness of environmental pollution from fine particulates and increasing enforcement of COSHH and environmental legislation, the demand for more area and perimeter monitoring on a short to medium term basis is on the increase. This need for real-time particulate information is a requirement in general industry, when looking at Total Suspended Particulate (TSP), and at inhalable and respirable dust levels as a health issue.



The Dust Detective Static Air Sampling enclosure was designed for exactly this application. This accessory provides a simple solution for short to medium term fixed area monitoring with the Microdust Pro and Apex2 sampling pumps and is designed specifically for use in indoor applications, but some short-term outdoor perimeter samples can be undertaken with the unit. It should run for up to 13 hours in situ on the internal batteries.



It is possible to gain gravimetric results from the Dust Detective and PUF foam inserts can be used to allow the size selection of the environmental fractions PM10 and PM2.5. Data can also be downloaded for full analysis and time history of the data.

The IP65 case is designed to accommodate a standard Microdust Pro as well as an Apex2 air sampling pump which provides a precise inlet flow rate.

Guardian2

The Guardian2 is a system for web-based, remote and long term monitoring of dust emissions to ensure compliance with the regulatory limits. It is ideal for demolition and construction monitoring, roadside or traffic monitoring, or waste sites allowing the site manager to set up site strategies for dust management or for general compliance monitoring.

Data is pushed automatically to a dedicated website, casella247.com, using a private login and is accessible in real-time 24 hours a day, 365 days a year. A report can be readily produced for compliance purposes and in addition the system provides alerts via text message or email should the limits be exceeded.

The Guardian2 will simultaneously measure PM1.0, PM2.5 and PM10 in one minute, five minute, fifteen minute and one hour rolling averages with a sensitivity of $1\mu\text{g}/\text{m}^3$ and the inlet is heated to reduce moisture affecting measurements.

Wind speed and direction can be measured to establish dust sources and monitor site emissions.

It is possible to add additional parameters such as noise or vibration to this environmental boundary monitoring system.



Glossary

Term	Definition
Absorption	In air sampling, the take up and incorporation of a gas or vapour into another medium, e.g. chlorine gas dissolving into water in an impinger. See also Adsorption.
Active Sampling	Drawing contaminants in air through a suitable medium using a sampling pump. See also Passive Sampling.
Adsorption	In air sampling, the trapping of gases and vapours onto the surface of a suitable medium, e.g. Toluene onto Charcoal in sorbent tubes.
Aerodynamic Diameter	Relating to irregular shaped particles; the equivalent diameter of a regular particle (e.g. a spherical droplet) that has the same settling time as the irregular particle.
Aerosol	Solid or liquid particles of microscopic size in a gaseous medium Ambient Air. Refers to the air outdoors that we breathe.
Bioaerosols	Bioaerosols consist of airborne particles that contain living organisms, such as bacteria, fungi and viruses or parts of living organisms, such as plant pollen, spores and endotoxins from bacterial cells or mycotoxins from fungi.
Blank Sample	To ensure that the sample is valid; an identical sampling media that has not been exposed (i.e. not had air drawn through it) is analysed at the same time as the sample. See also Control Sample.
Ceiling Value	The maximum concentration of hazardous substance that should not be exceeded at any time during the working day.
Closed Face Sampling	Sampling where only the plugs are removed from the inlet of the cassette.

Constant Flow	A form of control system for the personal sampling pump. The pump automatically compensates for changes in pressure through the sampling period to maintain a constant flow. According to standards, this is $\pm 5\%$ of the set flow over the course of the sampling period.
Constant Pressure	A form of control system for the personal sampling pump. The pump automatically compensates for changes in flow through the sampling period to maintain a constant pressure. Useful for low flow measurements.
Control Sample	To ensure that the sample is valid; an identical sampling media that has not been exposed (i.e. not had air drawn through it) is analysed at the same time as the sample. See also Blank Sample.
COPD	Chronic Obstructive Pulmonary Disease (COPD) is a type of progressive lung disease that is preventable and treatable.
Cut Point	The cut point relates to size selective samplers. A 50% cut point, for instance, would be the specified size of fraction that would be collected with 50% efficiency.
Cyclone	In air sampling, this refers to a specific type of head which separates out size fractions, e.g. respirable. It forces the air that is drawn into a rapidly circulating motion causing the larger fractions to drop out and the fraction of interest to be collected on the filter.
Desorption	The physical process where a previously adsorbed substance is released from a surface.
Dust	Particles of solid matter, in the range of 1 micron to 1 millimetre diameter. Anything larger than that is considered to be grit and will be too heavy to remain airborne.

Filter Cassette	The protective casing that holds the filter media.
Flocculation	Solid particles adhering together to form larger irregular particles. Tends to happen with fumes and is of importance because the airborne characteristics change. (This is also a term for particle behaviour in liquids).
Fugitive Emissions	Emissions of gases or vapours from pressurized equipment due to leaks and other unintended or irregular releases of gases.
Fume	Solid particles produced by condensation from a gas. The particle size of a fume <1 micron diameter. Anything larger is considered a dust particle.
Gas	One of the four states of matter (liquid, solid & plasma are the others) What distinguishes a gas from liquids and solids is the large separation of the individual atoms/molecules.
GC	Gas Chromatography (GC) is used for separating and analysing compounds that can be vapourised without decomposition.
GFA	Glass Fibre (GFA) is a type of filter media most commonly used for gravimetric analysis.
Grab Sampling	The collection of an air sample directly into a bag for analysis at a laboratory or through a detector tube. Gives results for a point in time.
Gravimetric Analysis	Analysis of samples by pre- and post-weighing of filter media.
Grit Pot	Collects the larger particles that are not the desired fraction in cyclone heads.

Hazardous Area	<p>Is an area in which the atmosphere contains, or may contain in sufficient quantities, flammable or explosive gases, dusts or vapours.</p> <p>Intrinsic Safety (IS) is an approach to the design of equipment going into hazardous areas.</p>
Inhalable Fraction	<p>The fraction of airborne material which enters the nose and mouth during breathing and is therefore liable to deposition anywhere in the respiratory tract. The particle sizes of Total Inhalable Dust are up to 100 microns.</p>
Integrated Sampling	<p>Air sampling over a longer period of time.</p>
Match Weighed Filters	<p>A cassette containing two filters which are matched in weight, one sitting behind the other as a blank. When re-weighed, the result is the difference between the two.</p>
MCE	<p>Mixed Cellulose Ester (MCE) is a type of filter media most commonly used for metals and fibres analysis. Stronger than glass fibre and ideal for post analysis of samples other than weighing.</p>
Media Filter	<p>Generally a circular disc of material designed to capture solid particulate. Made from a variety of material (GFA, MCE) dependent on your application.</p>
mg/m ³	<p>A measure of concentration by weight of airborne hazard.</p>
Mist	<p>Liquid particles, generally produced by bubbling, splashing or boiling of a liquid.</p>
Nanoparticle	<p>A particle in the range 1-100 nanometers (which 10⁻⁹ of a metre or 1 billionth of a metre).</p>
NIOSH	<p>The National Institute for Occupational Safety and Health (NIOSH) is the US federal agency responsible for</p>

	conducting research and making recommendations for the prevention of work related injury or illness.
Open Faced Sampling	Sampling using a 3-piece cassette where the top inlet section is removed rather than just the plug.
OSHA	The Occupational Safety and Health Administration (OSHA) is a regulatory agency of the US Department of Labor that had federal visitorial powers to inspect and examine workplaces.
Passive Sampling	Also known as Diffusive Sampling. Hazardous substances diffuse onto a sorbent medium inside a badge sampler without being drawn through with a sampling pump.
PM10	A particle size fraction, generally used in environmental monitoring rather than personal exposure. Roughly equates to the Thoracic Fraction in the Occupational Convention.
PM2.5	A particle size fraction, generally used in environmental monitoring rather than personal exposure.
Pore Size	The pore size of filter media is identified by the diameter of the particle that it can be expected to retain with a defined, high degree of efficiency. Pore sizes are usually stated in micrometer or microns for short (μm), which equals one millionth of a meter.
PPM	A measure of concentration by volume of airborne hazard.
Preweighed Filters	Weighed before sampling to high degree of accuracy and then loaded into a cassette for sampling. The filter must be re-weighted afterwards at the same laboratory/balance.
Primary Standard	In air sampling terms, it measures flow by means of a calibrated cylinder which will not change its dimensions over time or environmental conditions.

PTFE	PolyTetraFluoroEthylene (PTFE) is a type of filter media most commonly used for corrosive substances. Stronger than glass fibre and ideal for post analysis of samples other than weighing.
PVC	PolyVinylChloride (PVC) is a type of filter media most commonly used for silica and chromium analysis. Stronger than glass fibre and ideal for post analysis of samples other than weighing.
Respirable Fraction	This is the fraction of dust that penetrates to the deep lung where gas exchange takes place. The particle sizes of respirable dust are up to 10 microns.
Sampling Train	The setup of the sampling equipment: sampling head, filter, tubing and pump.
Secondary Standard	An example would be rotameter which can be affected by temperature, pressure and subjective viewing. Used for quick calibrations in the field. These devices must be calibrated against a primary standard periodically.
Short term exposure	Generally a 15 minute exposure measurement limit (STEL).
Smoke	Collection of airborne particulates and gases emitted when a material undergoes combustion.
TEM	Transmission Electron Microscopy (TEM) is a microscopy technique in which a beam of electrons is transmitted through a specimen to form an image.
Thoracic Fraction	The fraction of airborne material which can be deposited in the lungs and gas exchange regions. 10 μ m, 50% cut point.
Total Inhalable Dust	The fraction of airborne material which enters the nose and mouth during breathing and is therefore liable to deposition anywhere in the respiratory tract. The

	particle sizes of Total Inhalable Dust are up to 100 microns.
TWA	<p>The 8 hour Time Weighted Average. Exposure levels for a complete shift calculated by weighting concentrations throughout the day: (where c = concentration of substance and t = time exposed).</p> $TWA = \frac{c_1t_1 + c_2t_2 + \dots + c_n t_n}{8 \text{ Hours}}$
Vapour	The gaseous state of a substance which is liquid at 25°C and 760mm Hg (Standard Temperature and Pressure STP).
Vapour Intrusion	Is a process by which chemicals in soil or groundwater, especially VOC's migrate to indoor air above a contaminated site.
VOC	Volatile Organic Compounds (VOC) are organic compounds that can create a gaseous phase where it usually exists as a liquid or solid at room temperature.
Workplace Exposure Guidelines	Guidelines issued by governing bodies to set exposure limits.